



MTP3055E

N - CHANNEL 60V - 0.1Ω - 12A TO-220 STripFET™ MOSFET

TYPE	V _{DSS}	R _{DS(on)}	I _D
MTP3055E	60 V	< 0.15 Ω	12 A

- TYPICAL R_{DS(on)} = 0.1 Ω
- AVALANCHE RUGGED TECHNOLOGY
- 100% AVALANCHE TESTED
- 175°C OPERATING TEMPERATURE
- APPLICATION ORIENTED CHARACTERIZATION

APPLICATIONS

- HIGH CURRENT, HIGH SPEED SWITCHING
- SOLENOID AND RELAY DRIVERS
- REGULATORS
- DC-DC & DC-AC CONVERTERS
- MOTOR CONTROL, AUDIO AMPLIFIERS
- AUTOMOTIVE ENVIRONMENT (INJECTION, ABS, AIR-BAG, LAMPDRIVERS, Etc.)

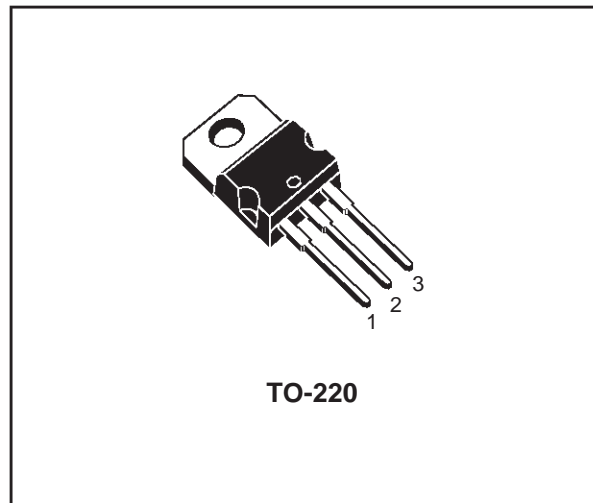

ABSOLUTE MAXIMUM RATINGS

Symbol	Parameter	Value	Unit
V _{DS}	Drain-source Voltage (V _{GS} = 0)	60	V
V _{DGR}	Drain- gate Voltage (R _{GS} = 20 kΩ)	60	V
V _{GS}	Gate-source Voltage	± 20	V
I _D	Drain Current (continuous) at T _c = 25 °C	12	A
I _{DM}	Drain Current (pulsed) at T _c = 100 °C	9	A
I _{DM} (•)	Drain Current (pulsed)	48	A
P _{tot}	Total Dissipation at T _c = 25 °C	40	W
T _{stg}	Storage Temperature	-65 to 175	°C
T _j	Max. Operating Junction Temperature	175	°C

(•) Pulse width limited by safe operating area
First digit of the datecode being Z or K identifies silicon characterized in this datasheet.

MTP3055E

THERMAL DATA

$R_{thj-case}$	Thermal Resistance Junction-case	Max	3.75	$^{\circ}C/W$
$R_{thj-amb}$	Thermal Resistance Junction-ambient	Max	62.5	$^{\circ}C/W$
R_{thc-s}	Thermal Resistance Case-sink	Typ	0.5	$^{\circ}C/W$
T_l	Maximum Lead Temperature For Soldering Purpose		300	$^{\circ}C$

AVALANCHE CHARACTERISTICS

Symbol	Parameter	Max Value	Unit
I_{AR}	Avalanche Current, Repetitive or Not-Repetitive (pulse width limited by T_j max)	12	A
E_{AS}	Single Pulse Avalanche Energy (starting $T_j = 25^{\circ}C$, $I_D = I_{AR}$, $V_{DD} = 25 V$)	50	mJ

ELECTRICAL CHARACTERISTICS ($T_{case} = 25^{\circ}C$ unless otherwise specified)

OFF

Symbol	Parameter	Test Conditions	Min.	Typ.	Max.	Unit
$V_{(BR)DSS}$	Drain-source Breakdown Voltage	$I_D = 250 \mu A$ $V_{GS} = 0$	60			V
I_{DSS}	Zero Gate Voltage Drain Current ($V_{GS} = 0$)	$V_{DS} = \text{Max Rating}$ $V_{DS} = \text{Max Rating} \times 0.8$ $T_c = 125^{\circ}C$			1 10	μA μA
I_{GSS}	Gate-body Leakage Current ($V_{DS} = 0$)	$V_{GS} = \pm 20 V$			± 100	nA

ON (*)

Symbol	Parameter	Test Conditions	Min.	Typ.	Max.	Unit
$V_{GS(th)}$	Gate Threshold Voltage	$V_{DS} = V_{GS}$ $I_D = 250 \mu A$	2	2.9	4	V
$R_{DS(on)}$	Static Drain-source On Resistance	$V_{GS} = 10V$ $I_D = 7 A$		0.1	0.15	Ω
$I_{D(on)}$	On State Drain Current	$V_{DS} > I_{D(on)} \times R_{DS(on)max}$ $V_{GS} = 10 V$	12			A

DYNAMIC

Symbol	Parameter	Test Conditions	Min.	Typ.	Max.	Unit
$g_{fs} (*)$	Forward Transconductance	$V_{DS} > I_{D(on)} \times R_{DS(on)max}$ $I_D = 6 A$	4	6		S
C_{iss}	Input Capacitance	$V_{DS} = 25 V$ $f = 1 MHz$ $V_{GS} = 0$		760		pF
C_{oss}	Output Capacitance			100		pF
C_{rss}	Reverse Transfer Capacitance			30		pF

ELECTRICAL CHARACTERISTICS (continued)
SWITCHING RESISTIVE LOAD

Symbol	Parameter	Test Conditions	Min.	Typ.	Max.	Unit
$t_{d(on)}$	Turn-on Time	$V_{DD} = 30\text{ V}$ $I_D = 7\text{ A}$ $R_G = 50\ \Omega$ $V_{GS} = 10\text{ V}$ (see test circuit)		20		ns
t_r	Rise Time			65		ns
$t_{d(off)}$	Turn-off Delay Time			70		ns
t_f	Fall Time			35		ns
Q_g	Total Gate Charge	$I_D = 12\text{ A}$ $V_{GS} = 10\text{ V}$		15		nC
Q_{gs}	Gate-Source Charge	$V_{DD} = 40\text{ V}$		7		nC
Q_{gd}	Gate-Drain Charge	(see test circuit)		5		nC

SOURCE DRAIN DIODE

Symbol	Parameter	Test Conditions	Min.	Typ.	Max.	Unit
I_{SD}	Source-drain Current				12	A
$I_{SDM}(\bullet)$	Source-drain Current (pulsed)				48	A
$V_{SD} (*)$	Forward On Voltage	$I_{SD} = 12\text{ A}$ $V_{GS} = 0$			2.0	V
t_{rr}	Reverse Recovery Time	$I_{SD} = 12\text{ A}$ $di/dt = 100\text{ A}/\mu\text{s}$ $V_{DD} = 30\text{ V}$ $T_j = 150\text{ }^\circ\text{C}$		65		ns
Q_{rr}	Reverse Recovery Charge			0.17		μC

(*) Pulsed: Pulse duration = 300 μs , duty cycle 1.5 %
 (•) Pulse width limited by safe operating area

Safe Operating Area

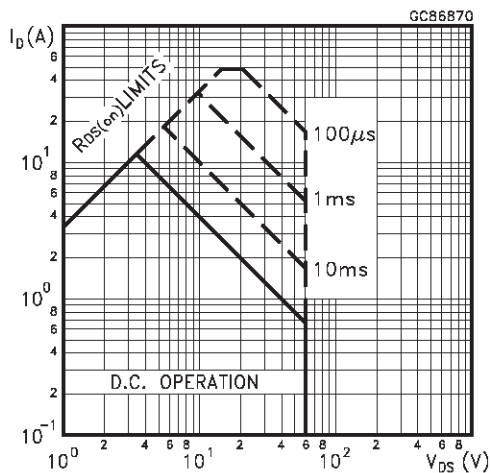

Thermal Impedance

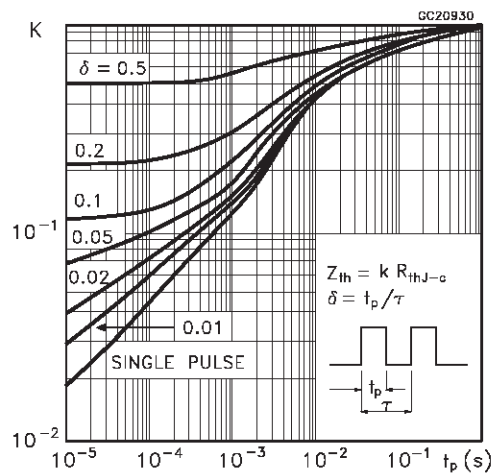

Output Characteristics

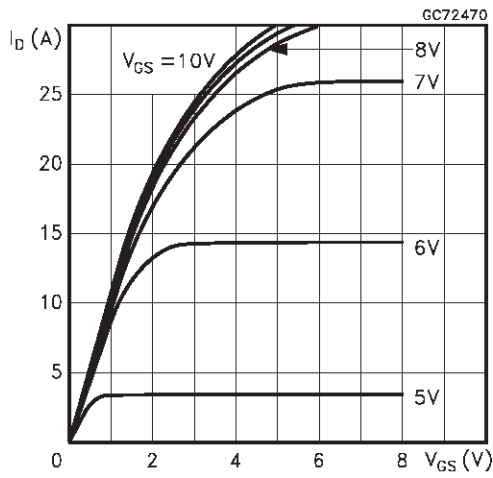

Transfer Characteristics

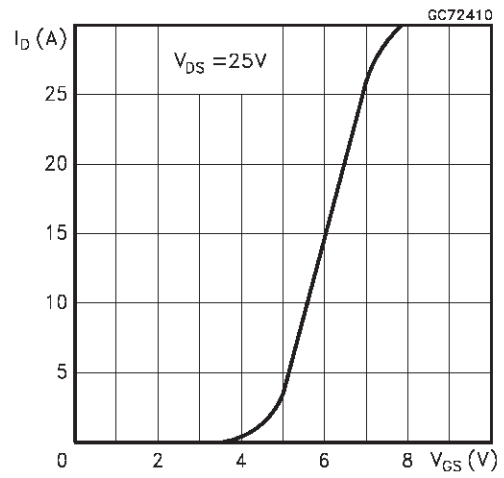

Transconductance

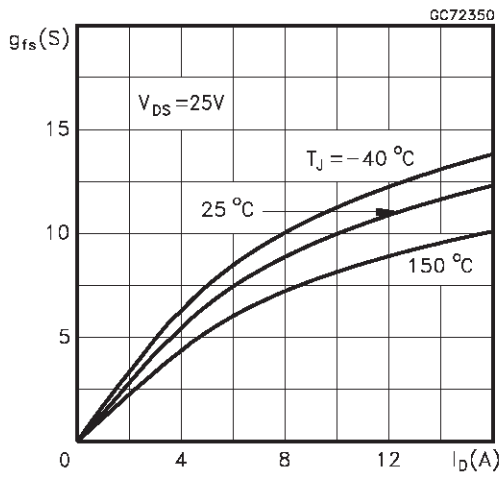

Static Drain-source On Resistance

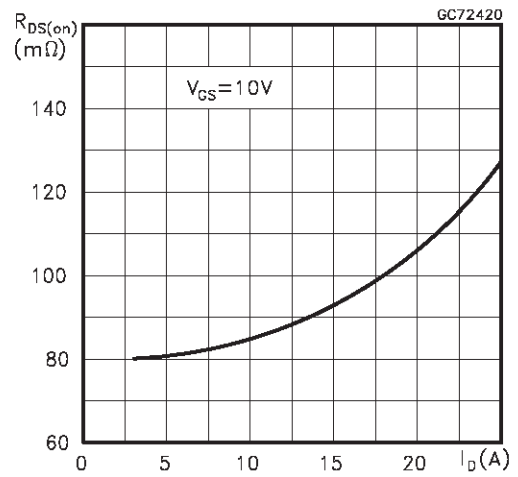

Gate Charge vs Gate-source Voltage

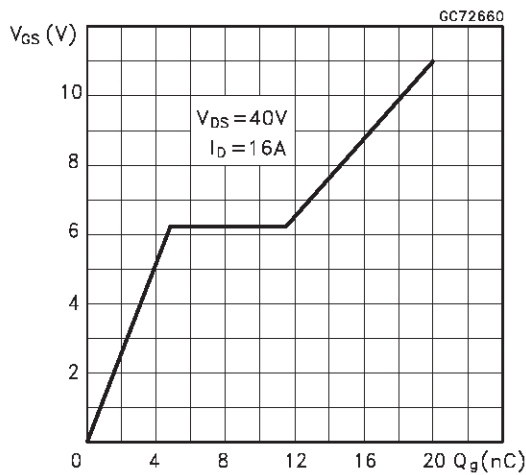

Capacitance Variations

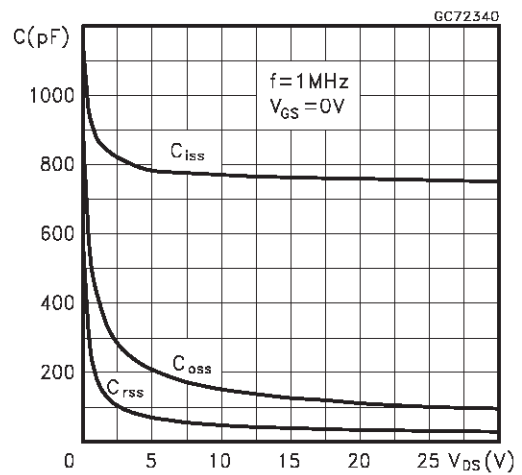

Normalized Gate Threshold Voltage vs Temperature

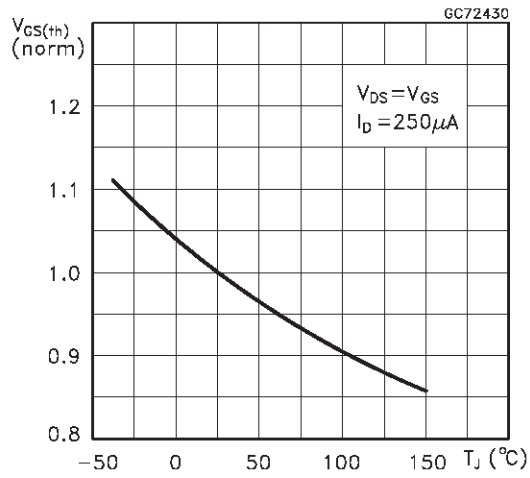

Normalized On Resistance vs Temperature

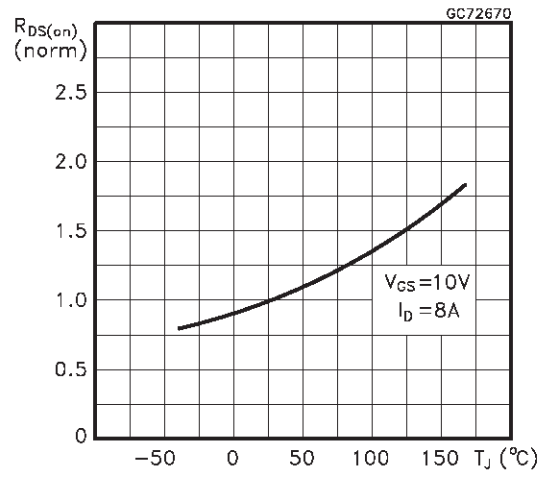

Source-drain Diode Forward Characteristics

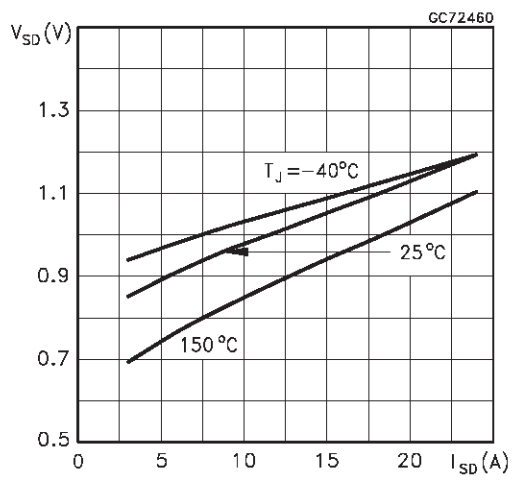

Fig. 1: Unclamped Inductive Load Test Circuit



Fig. 2: Unclamped Inductive Waveform

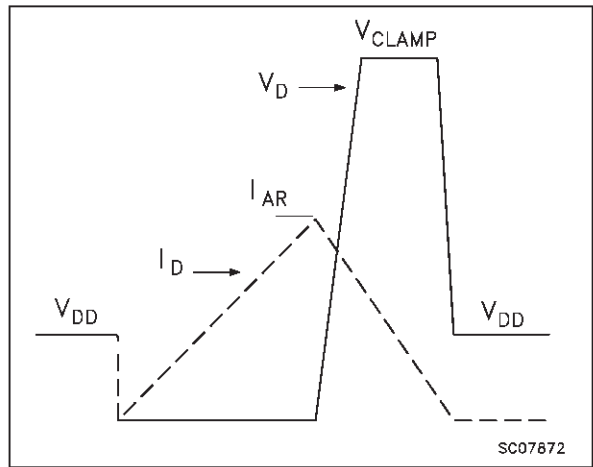

Fig. 3: Switching Times Test Circuits For Resistive Load



Fig. 4: Gate Charge test Circuit



Fig. 5: Test Circuit For Inductive Load Switching And Diode Recovery Times



TO-220 MECHANICAL DATA

DIM.	mm			inch		
	MIN.	TYP.	MAX.	MIN.	TYP.	MAX.
A	4.40		4.60	0.173		0.181
C	1.23		1.32	0.048		0.051
D	2.40		2.72	0.094		0.107
D1		1.27			0.050	
E	0.49		0.70	0.019		0.027
F	0.61		0.88	0.024		0.034
F1	1.14		1.70	0.044		0.067
F2	1.14		1.70	0.044		0.067
G	4.95		5.15	0.194		0.203
G1	2.4		2.7	0.094		0.106
H2	10.0		10.40	0.393		0.409
L2		16.4			0.645	
L4	13.0		14.0	0.511		0.551
L5	2.65		2.95	0.104		0.116
L6	15.25		15.75	0.600		0.620
L7	6.2		6.6	0.244		0.260
L9	3.5		3.93	0.137		0.154
DIA.	3.75		3.85	0.147		0.151



Information furnished is believed to be accurate and reliable. However, STMicroelectronics assumes no responsibility for the consequences of use of such information nor for any infringement of patents or other rights of third parties which may result from its use. No license is granted by implication or otherwise under any patent or patent rights of STMicroelectronics. Specification mentioned in this publication are subject to change without notice. This publication supersedes and replaces all information previously supplied. STMicroelectronics products are not authorized for use as critical components in life support devices or systems without express written approval of STMicroelectronics.

The ST logo is a trademark of STMicroelectronics

© 1999 STMicroelectronics – Printed in Italy – All Rights Reserved
STMicroelectronics GROUP OF COMPANIES

Australia - Brazil - China - Finland - France - Germany - Hong Kong - India - Italy - Japan - Malaysia - Malta - Morocco -
Singapore - Spain - Sweden - Switzerland - United Kingdom - U.S.A.